

DVD Player User's Manual

DVD-3

NOTICE:

For additional information or for the location of an authorized service center, please contact KEC Mobile Applications / KTV USA, Inc. at (800) 524-1216 or (973) 470-9191

-  is the prohibition mark. If this appears when you operate the product, wait until it disappears. If this phenomena repeats, the current button does not cope with the disk in play.
- Please keep this product horizontal. Otherwise, it won't operate.





Safety Precautions

Do read and use the followings carefully for your safety and product protection.

Cautions are composed of Warning and Attention which mean the followings respectively.

Warning : Possibility of fatal injury or death

Attention : Possibility of minor injury or product damage

Warning

Put the cigar jack into the deepest point to prevent shaking.

- It may cause a poor contact or fire.



Never use any damaged cigar jack.

- It may cause a poor contact or fire.



Never touch the cigar jack with wet hands.

- It may cause a fire or electric shock.



Never hold the product with your hands while the disk is in play.

- It may cause a breakdown of disk or product.



Be careful not to get the cigar jack cable entangled.

- It may cause an accident.



Do not expand the cigar jack too severely.

- It may cause the battery discharge from instable voltage.



Grab the cigar jack firmly to pull it out.

- If not, it may cause a heat emission or fire.



Watching or adjusting is prohibited during drive.

- It may cause a traffic accident.

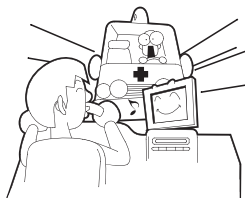

Secure your vision from the product.

- It may cause a traffic accident.

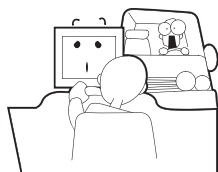

Attention

Don't put books or water-filled vessels.

- It may cause a breakdown.



Neither use nor store ignitable sprays or inflammable materials in the vicinity.

- It may cause an explosion or fire.



Don't put metals(coin, hair pin, ironware, etc.) or burnable foreign materials(match, paper, etc.) in the disk inlet or port hole.

- It may cause a fire or electric shock.

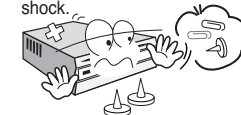

Put the product at a flat and stable place.

- Otherwise, It may cause a wrong operation.



Never disassemble or modify the product on your own.

- It may cause a breakdown.

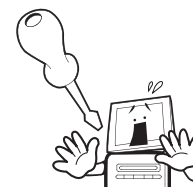

Avoid the vicinity of the handle knob for installation.

- It may cause a traffic accident.



Keep the remote control away from the brake pedal.

- It may cause a traffic accident.

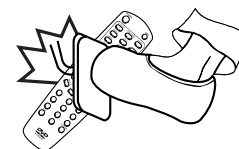

Keep the volume reasonable.

- It may cause an interfering other drivers and being ignorant of surrounding situation.

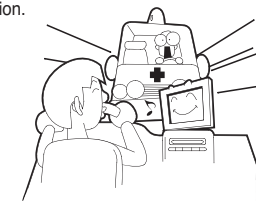



Special Features

- **Covers DVD, VCD, SVCD, and CDDA**
- **Covers play MP3, MPEG4 and JPEG(i.e. CD-R, CD-RW, DVD-R, DVD+R, DVD-RW, and DVD+RW disk containing MP3 or JPEG)**
- **OSD(On Screen Display)**
Press [DISPLAY] to display the information on the DVD/VCD/CD disk and the device.
- **Dolby Digital Decoder is built in.**
- **Composite Video Output(x1)**
- **Slow Forward and Reverse Playback(DVD)**
- **Fast Forward and Reverse Playback(DVD)**
- **Title, Chapter, and Time Search for DVD and Track and Time Search for VCD/CD**
- **Various Screen Ratio(DVD)**
4:3 Zoom(Pan and Scan), 4:3 General(Letter Box), and 16:9 Wide(Wide)
- **Repeat Play(Title and Chapter for DVD and Track and disc for VCD/CD)**
- **Repeat Play of Specific Area(A-B)**
- **Selective Play(DVD/VCD/CD)**
Title or Chapter for DVD and Track for Video CD/CD
- **Various Voice Language(DVD)**
Up 8 Voice Languages.
The number of languages depends on the disc for SVCD and VCD.
- **Various Open Caption Language(DVD)**
Up 32 Open Caption Languages.
The number of languages depends on the disc for SVCD and VCD.
- **Various Angle Screen(DVD)**
Simultaneous Multi Screen at Various Angles(The number of screens depends on the disc.)
- **Screen Zoom**
- **Free Volt**
From 12V to 24V
- **S-VIDEO OUTPUT(x1)**



Contents

Preparations

Safety Precautions	2
Special Features	4
Disc Information	6
Disc Handling and Storage.....	7
Parts Name & Description(Front, Front panel Display, Rear)	8
Parts Name & Description (Remote Control Battery Change)	11
Parts Name & Description(Cautions for Battery Handling).....	11
Parts Name & Description (Name and Function of Remote Control Buttons).....	12

Connection

Precautions for DC Input/Output Port Use ..	14
Connecting to TV/Audio	15

Setup

Function Setup(Setup Menu)	16
GENERAL Setup	17
AUDIO Setup	18
PREFERENCES	19

Use

Disc Play(DVD, VCD, CD)	21
Checking DISPLAY	22
Checking disc Menu	23
Changing Disc Audio/Subtitle language during the playback	23
Searching Video track/Music	24
Slow Play	25
Repeat Play	26
Zooming-In/Angling	27
Searching Screen/Music	28
Playing MP3 Disc	29
Photo View by JPEG Disc	30
MPEG4 DISK PLAY	31

Others

TroubleShooting	32
Product Specification	34
REFERENCE	35



Disc Information



DVD(Digital Versatile Disc) is a disc with a maximum capability of 135 minutes long image, 8 Disc Audio languages, and 32 Subtitle languages. It also has the function of MPEG-2 type image compression and dolby digital 3D surround so that you are able to bring a movie theater at home enjoying vivid image and clean sound quality.



Both DVD player and disc have encoded country codes that you have to accord with before use.

Disc for Play

Disk Type	Disk Logo	Saved Signal	Disc Size
DVD VIDEO DVD-R DVD+R DVD-RW DVD+RW	 	Audio + Video	12 cm
VCD		Audio + Video	12 cm
CD		Audio	12 cm
CD-R			
CD-RW			



Dolby Digital



Digital Audio Disk



Stereo Disk



Broadcasting Method



MP3 Disc

- Other discs than specified above shall not be used for this device.
- DVD, DVD-Audio, DVD-ROM, and CD-ROM with an incompatible area code shall not be used for this device.
- The area code for the player is written in the back.



Disc Handling and Storage

Even tiny scratch on the disc may affect the screen. Please take special care.

Disc Handling

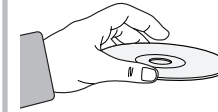

- Press the center holder to put a disc out of the case with convenience.
- Do not touch the disc surface but refer to the figure to move a disc.
- Do not stick paper or tape on a disc. It may be bent.
- Do not leave fingerprint or dust on a disc. Be sure to check and clean any before use.



- Do not let dust or foreign materials on a disc.
- Do not use broken or scratched discs.

Disc Storage

Without direct ray

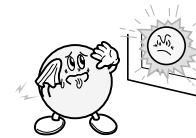

Good ventilation

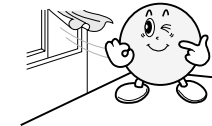

Available for vertical storage

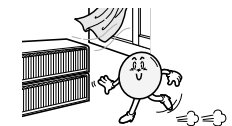

- Sudden temperature rise may dew the operating part or lens of a product, resulting in play failure. If then, supply power and insert a disc 1 or 2 hours later.

Disc Handling



For a disc stained by fingerprints or dirty foreign materials, wipe it out with neutral rinse and water and dry it with a soft towel.

- From inside to outside



- Do not use chemicals such as thinner, benzene, commercial rinse, alcohol, or static electricity preventive spray for LP at all times. This may hurt the disc.



Parts Name & Description

Front

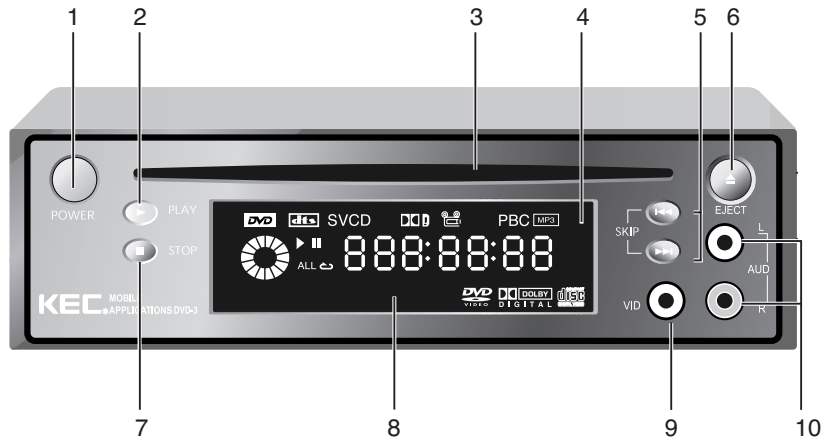

- 1 POWER**
Turns on/off power.
- 2 PLAY**
Plays discs.
- 3 Disc SLOT**
Receives and discharges discs.
- 4 Remote Sensor**
Receives signals at a remote control.
- 5 NEXT/BACK**
Skips chapters or tracks.
- 6 EJECT**
Takes out discs.
- 7 STOP**
Stops disc operation.
- 8 Display Window**
Shows the current condition of players or discs.
- 9 VIDEO IN**
Connects a video cable with a video input port and a video output port of other device.
- 10 AUDIO IN**
Connects an audio cable with an audio input port and an audio output port of other device.

Front Panel Display

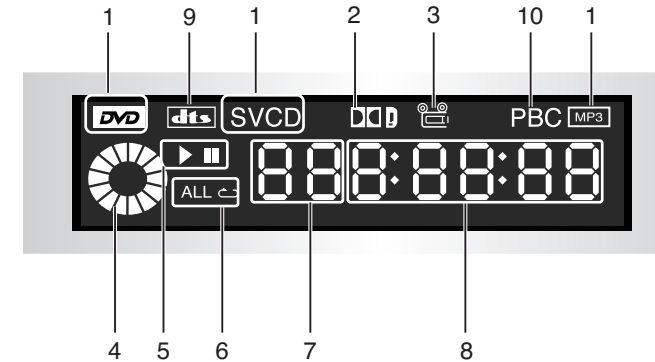

- 1 DVD/SVCD/VCD/CD/MP3**
Displays the disc type inserted in the main body.
- 2 Dolby Digital**
Indicates the disc in play was recorded by dolby sound effect.
- 3 ANGLE**
Indicates the disc in play is being watched at various angles.
- 4 ROTATE**
Indicates a disc is rotating.
- 5 PLAY/PAUSE**
Displays the current operation mode.
- 6 REPAT/ALL**
Displays the current Repeat/Play mode.
- 7 TITLE/CHAPTER**
Displays the title or chapter information on the DVD disc in play.
- 8 VISION**
Displays the information on vision and operation modes such as Play, Stop, Disc-Confirmed, or No-Disc.
- 9 dts**
Indicates the disc in play was recorded by dts sound effect.
 · Choice dts sound off.
- 10 PBC (Play Back Control)**
Displays the PBC operation condition while VCD plays.



Parts Name & Description

Rear

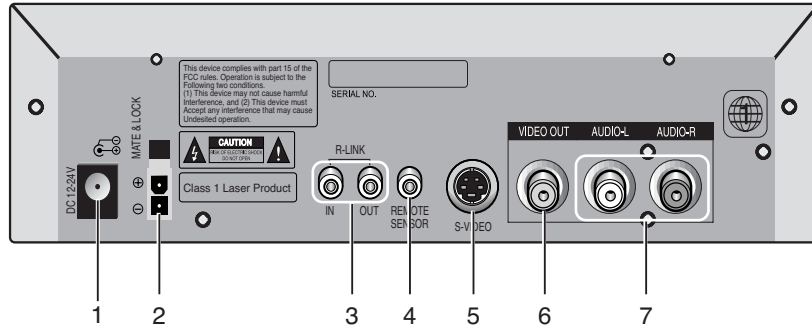

- | | |
|--|---|
| <p>1 DC INPUT
Use the cigar jack for connection.(extra)</p> <p>2 DC INPUT
Use the DC power cable for connection.</p> <p>3 R-LINK IN/OUT
Allows remote control of any KEC Mobile Applications video product in the R-LINK chain even if it is hidden from view.</p> <p>4 EXTERNAL REMOTE CONNECTOR
Use the external remote control cable.</p> | <p>5 S-VIDEO
Connect the S-Video cable with the S-Video output port and TV S-Video input port for the better resolution.</p> <p>6 VIDEO OUT
Connect the Video cable with the Video output port and TV Video input port.</p> <p>7 AUDIO OUT
Connect the Audio cable with the Audio output port and TV or Receiver Video input port.</p> |
|--|---|



Parts Name & Description

Remote Control Battery Change



1. Push the battery lid in the arrow direction to open it.
2. Put batteries in, checking their polarity. (1.5V, AAx2)
3. Push the battery lid back in the arrow direction to close it.

Using Remote Control

The remote control can cover as long as 7m from the DVD receiver and up to 30° to the left and right.

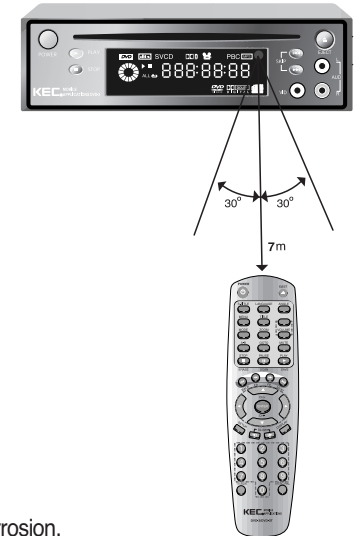

Cautions for Battery Handling

- Poor battery use may cause battery liquid leak or corrosion.
- Check the polarity when you put batteries in.
- Never expose a battery to heat or fire. Never disassemble or short a battery.
- Check if a dead battery is in the remote control.
- Never combine batteries of different type. Do not leave an old battery when you put a new battery in.
- When you don't use the remote control for a long time, please take out all batteries to prevent their corrosion.
- In case of poor operation of the remote control or shorter operation distance, replace the batteries.
- In case of battery liquid leak, clean the liquid from the remote control and replace the batteries.



Parts Name & Description

Name and Function of Remote Control Buttons

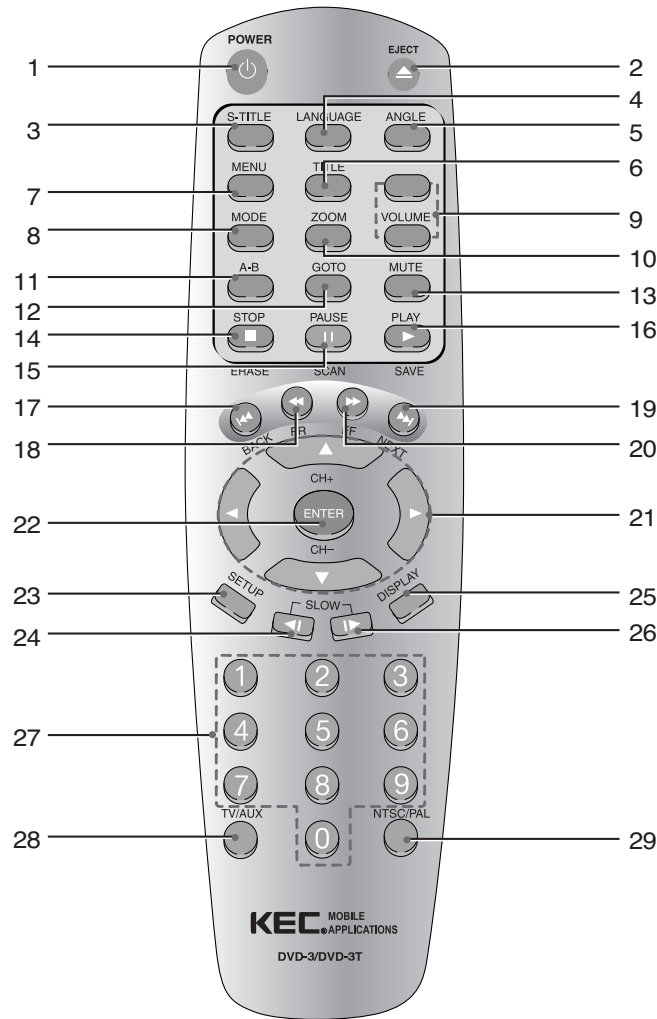

- 1 POWER**
Turns on/off the DVD player.
- 2 EJECT**
Pulls out a disc.
- 3 S-TITLE**
Chooses a closed caption language. But it is available only when the disc supports various closed caption languages.
- 4 LANGUAGE**
Selects a voice language. But it is available only when the disc supports various voice languages.
- 5 ANGLE**
Shows a screen at various angles. But it is available only when the disc supports various angles.
- 6 TITLE**
Displays the title of a disc in play.
- 7 MENU**
Displays the menu of a disc in play.
- 8 MODE**
Selects PLAY or REPEAT DISC.
- 9 VOL**
Volumes up or down.
- 10 ZOOM**
Zooms in/out the screen.
- 11 A - B**
Repeats a selected area.
- 12 GOTO**
Jumps to a DVD disc title/track or chapter.
- 13 MUTE**
Erases voice.
- 14 STOP**
Stops disc play.
- 15. PAUSE**
Pauses disc play.
- 16. PLAY**
Plays a disc.
- 17. BACK**
Moves back to the previous chapter(DVD) or track(VCD, CDDA).
- 18. FR**
Rewinds a disc at the speed of x2, x8(DVD, VCD), or x16(CD, MP3).
- 19. NEXT**
Turns to the next chapter(DVD) or track(VCD, CDDA).
- 20 FF**
Forwards a disc fast at the speed of x2, x8(DVD, VCD), or x16(CD, MP3).
- 21 MOVE**
Moves to an item in the menu.
- 22 ENTER**
Selects a menu item.
- 23 SETUP**
Sets up various functions to one's taste.
- 24 SLOW**
Rewinds a disc at the speed from x1/2 to x1/4.
- 25 DISPLAY**
Moves to the title/track or chapter of a disc.
- 26 SLOW**
Forwards a disc slowly at the speed from x1/2 to x1/4.
- 27 NUMERIC BUTTONS**
Jumps to a song of a CD or MP3.
- 28 AUX**
Plays video/audio signals from outside.
- 29 NTSC/PAL**
Use to choose broadcasting methods. (Only when DVD player is not operating)



Precautions for DC Input/Output Port Use

1 When using the DC power supply cable(DC Power Supply Cable)

Connect the red cable port to ACC (DC 12V~24V) and the black one to the ground.

Use ② of Page 10.

2 When using the car cigar jack(Extra Goods)

Check if the car cigar jack output voltage is DC 12V ~ 24V before you put it in the DC input port.

Use ① of Page 10.



Checking Accessories

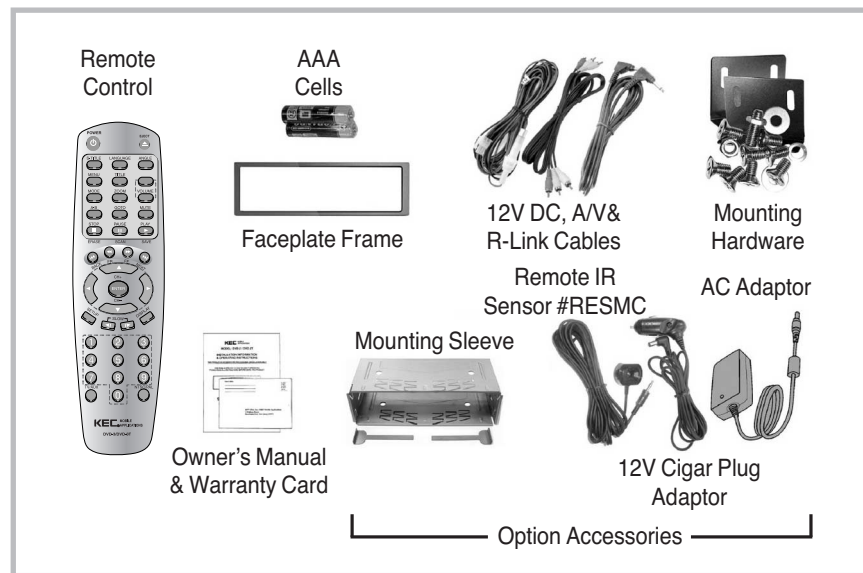

● Please call the shop where you bought our product to buy other extra goods than specified above.



Connecting to TV/Audio

Wiring Diagram

When using the AUX input port of the head unit

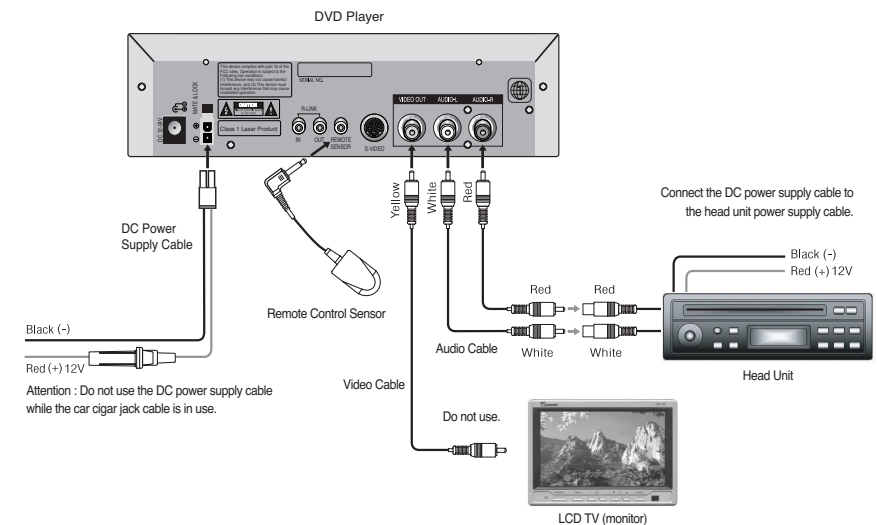

1 Connect the audio cable to the Audio Output(L/R) port in the back of the DVD player and the Audio Input port of the car stereo.

2 Connect the video cable to the Video Output port in the back of the DVD player and the Video Input port of TV.



• When using the DC power supply cable(DC Power Supply Cable) Connect the red cable port to ACC (DC 12V~24V) and the black one to the ground. (Use ② of Page 10.)



Function Setup

- Press SETUP when a disc is not running to enter DVD and the following screen to preset various menus will appear as follows. Here comes the information do display.
- The default setting will be left unchanged by power on or off.

Using Setup Menu



- 1 Press [SETUP] button when a disc is not running.
 - The SETUP menu appears.

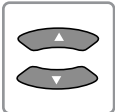
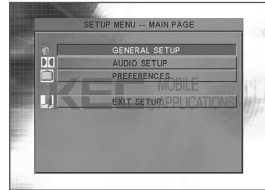

- 2 Press ▲ ▼ buttons to move to the SETUP menu.

- **GENERAL SETUP** Refer to GENERAL of Page 17. You can set up OSD Languages.
- **AUDIO SETUP** Refer to GENERAL of Page 18. It can be set Audio output ways.
- **PREFERENCES** Refer to GENERAL of Page 19. It can be set TV display, TV type, AUDIO language, Subtitle language, Disc menu-language, start working.

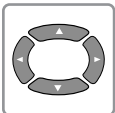

- 3 Press [ENTER] button move to your wanted sub menu with button ▼ and by button ► move to detail menu , and then choose sub menu with button ▲ ▼.



- 4 Press [ENTER] button.
 - Setup process is completed.



- 5 Press [SETUP] button to exit the default menu.
 - Exits the default menu.



DVD Setup

GENERAL SETUP

It available set OSD language.



- 1 After [SETUP] button Remote controller , Press choice for general function.

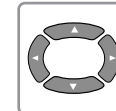
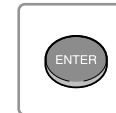
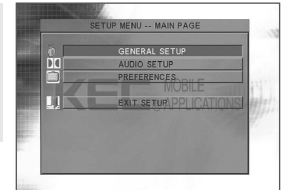

- 2 Press ► button to your wanted OSD Language.



- **OSD Language.**
For choosing language shown on the DVD Player.



- 4 Press [ENTER] button.
 - Setup process is complete.
 - For back from start screen of setting, Press SETUP button.



DVD Setup

AUDIO SETUP

It can be set the output of audio signal which has been recoded in disc.



1

After Press [SETUP] button move to Audio setting menu by ▲ ▼ button and then choose.

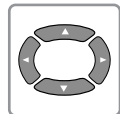
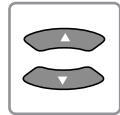

2

Move to ► button and choose your wanted item.

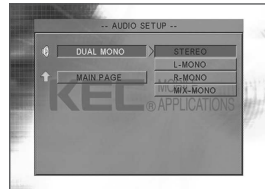

- **Stereo**
Listening by stereo of CD.
- **L-MONO**
Listen only Left side of CD.
- **R-MONO**
Listen only Right side of CD.
- **MIX-MONO**
Listen mixing sound of Left and Right side.



DVD Setup

PREFERENCES

It can be set TV display, TV type, AUDIO language, Subtitle language, Disc menu language, start working.



1

After Press [SETUP] button move to Preferences menu by ▲ ▼ button and then choose.

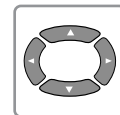
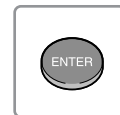
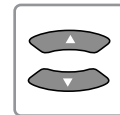
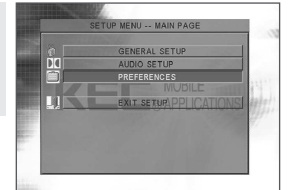

2

Choose your wanted by ▲ ▼ button.

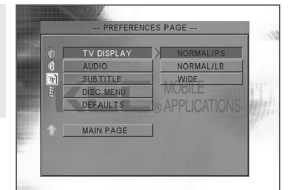

- **TV DISPLAY**
 - **NORMAL/PS** : Use in the case connecting usual PS: 4:3 ratio Standard TV.
It can be seen in all screen automatically after cut left and right side. It is only possible to be seen on the middle part of the screen in the ratio 16:9.
 - **NORMAL/LB** : Use in the case connecting usual LB: 4:3 ratio Standard TV.
It can be seen 16:9 ratio full screen but it could be seen totally small size because of empty spare of upper and down of the screen.
 - **WIDE** : Use in the case connecting wide TV or TV supported by wide mode availability. can be seen in the full screen 16:9 ratio without upper/down empty spare.

Note

- It can't be seen wide screen also by setting wide mode following DVD Title.
- It can be seen Usual PS or LB automatically also, following DVD Title.
- DVD title provide various ratio screen size so following the choice ratio, the ratio of width and vertical length could be different.



DVD Setup

● AUDIO LANGUAGE.

Choose language Korean, English, French, Spanish, Chinese, Japanese

If you are not choose the language, the vocal language will work following the recorded order of the priority vocal language automatically.

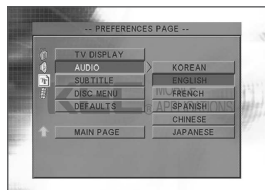

● SUBTITLE LANGUAGE.

Choose language applicable disk menu among Korean, English, French, Spanish, Chinese, Japanese, Off mode.

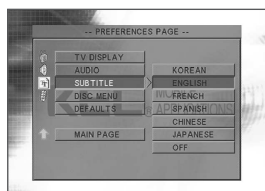

● DISK MENU LANGUAGE.

Choose language applicable disk menu among Korean, English, French, Spanish, Chinese, Japanese and Off mode.

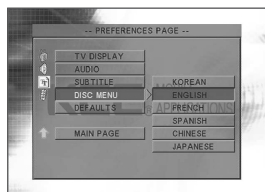

● RESET. (DEFAULTS)

Returns to the ex-work default.

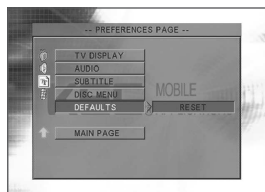

DISC PLAY

Before playing a disc

Check if the area code of your DVD player accord with that of a disc. If not, the disk won't operate.

Playing a disc (DVD, VCD, CD)



1 Press [POWER] button.



2 Let the labelled side(containing no data) of a disc face up and put the disc in.
• The disc will automatically operate.

● Stop(■) Button

Stops play.

● Play(▶) Button

- Press ▶ to play the point whose play was suspended before.
- Press ■ twice and press ▶ again to play a disc from the beginning.

● Pause(II) Button

- Pauses play of a disc.
- Whenever you press this button, the screen will change one by one.
- Press ▶ button again to replay the disc.



• The power is off in five minutes automatically in the case of not kept in disc in DVD mode in power on.



Checking DISPLAY

Depending on the disc type, the Voice Language/Closed Caption function operates. This function is available only during play.

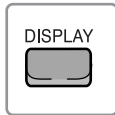

1 Press [DISPLAY] button.

- **DVD**
The current title, chapter, time will be displayed in the screen.
- **VCD**
Time, mode, Track is shown on the screen.



Checking Disc Menu

For the disc containing Menu, you may select one out of the various menus as follows.

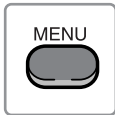

1 Press [MENU] button.

- The menu in the disc will appear.
- The menu differs by the disc.
- Whenever you press MENU button, PBC will be turned on and off in turn.(VCD 2.0)
- CD and VCD1.1 don't have this function.



2 Press ▼, ►, ▲ and ▼ buttons to move to an item and press [ENTER] button.

- Note**
- **What is Title?**
Refers to a movie file recorded in a DVD disc.
 - **What is Chapter?**
Refers to each chapter, a unit which classifies a movie file recorded in a DVD disc.
 - **What is Track?**
Refers to a unit or a music which divides a scene recorded in a VCD or CD list.



Changing Disc Audio/Subtitle language during the Playback

Depending on the disc type, the Disc Audio/Subtitle function may not operate. This function is available only during the playback.

Changing Disc Audio (DVD, VCD)



1 Press [LANGUAGE] button.

- For the disc containing the disc audio information, press LANGUAGE to select a variety of languages such as Kor, Eng, etc.(DVD)

- Note**
- The subtitle language mark may vary with the disc type.
 - A disc can contain as many as 8 subtitle languages.
 - If you want the disc audio language whenever you play DVD, set a disc audio language in the default setup.(See Page 20.)



Changing Subtitle Language (DVD)

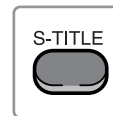

1 Press [S-TITLE] button.

- For the disc containing the subtitle information, press S-TITLE button to select a variety of languages such as Kor, Eng, Jap, etc.
- Press S-TITLE button to turn it off and the subtitle won't appear any more.

- Note**
- The subtitle language mark may vary with the disc type.
 - A disc can contain as many as 32 subtitles.
 - If you want the same subtitle language whenever you play DVD, set a subtitle language in the default setup.(See Page 20.)
 - The Disc Audio/Subtitle language selection function may be available depending on the disc type.
 - It won't operate after paused.
 - It is available only during DVD play.





Searching Video track/Music

During disc play, use the following functions to search a video track or a music.

Quick Search of Screen/Song (DVD, VCD, CD, MP3)



1 Press FR and FF and (⏮ ⏭) button in the remote control during play.

- **DVD**
The play speed will change x2 → x4 → x6 → x8 by pressing the button.
- **VCD/CD/MPEG4**
The play speed will change x2 → x4 → x8 → x16 by pressing the button.
- **MP3**
The play speed will change x2 → x4 → x6 → x8 by pressing the button.

- Press PLAY button to recover the normal play speed.
- During quick play, sound will be mute.(DVD/VCD)

Skipping Chapter(Track) (DVD, VCD, CD, MP3)



1 Press BACK and NEXT (⏮ ⏭) button in play.

- When pressing Back(⏮) button,
it returns to the previous chapter.
- When pressing NEXT(⏭) button,
it moves to the next chapter.



Slow Play

Slow Play (DVD)



1 Press SLOW (⏮ ⏭) button in PAUSE or PLAY.

- When pressing SLOW button (⏮),
it plays with x1/2, x1/3, x1/4 in the forward direction.
- When pressing SLOW button (⏭),
it plays with x1/2, x1/3, x1/4 in the reverse direction.

- Press PLAY () button to recover the normal play speed.
- During slow play, the sound will be mute.
- This function is not available while CD, MP3 or WMA plays.



Repeat Play

Repeating Play of Chapter, Title & Track(Music) (DVD/VCD/CD)

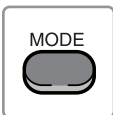

1 Press **MODE** () button during the disc playback.

- Whenever you press MODE button, the mode will keep changing in the following sequence.
- **DVD**
Chapter → Title → Off
- **VCD**
Track → All → Off
- **CD**
Track → All
- **MP3 / MPEG4**
Disc → Folder → Rap-one



- **DVD**
 - Off : When not playing in repeat
 - Title : When playing the current title in repeat
 - Chapter : When playing the current chapter in repeat
- **VCD**
 - Off : When not playing in repeat
 - Track : When playing the current track in repeat
 - All : When playing the current disc in repeat
- **CD**
 - Track : When playing the current track in repeat
 - All : When playing the current disc in repeat
- **MP3 / MPEG4**
 - Disc : When playing the current disc in repeat.
 - Folder : When playing the current Folder in repeat.
 - Repeat One : When playing the current file in repeat.

Repeating Certain Area (DVD/VCD/CD)

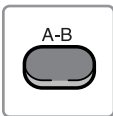

1 Press Repeat Area () button at the point that you want to repeat playing.

- Press the button at both the start point(marked 'A') and the end point(marked 'B') of the area that you want to repeat playing. Only the selected area will be played over and over again.
- Press the button once more to cancel this setup.

Note • The function may not be available depending on the disc type.



Zooming-In/Angling

Zooming-In (DVD/VCD)

You may zoom the screen by 2 steps during play or pause.

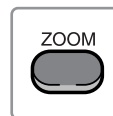

1 Press **ZOOM** () button in the Play or Pause mode.

- Whenever you press the button, the screen will be zoomed by the following ratio.
X1.5 → X2 → X3 → off

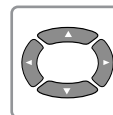
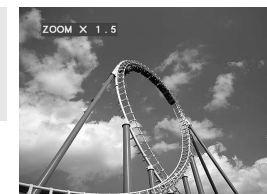



2 Press **▲, ▼, ◀ and ▶** buttons to move the zoomed area.

Changing the Camera Angle (DVD)

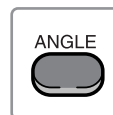
When a disc contains an area shot at various angles, you may see the screen at those angles.



1 Press **ANGLE** () button.

- The mark () will be displayed, presenting the maximum number of screen.

- Press ANGLE button to select the screen at an angle.
- In case the maximum number of screen is 1, the screen angle won't change.

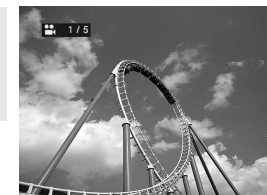



Searching Screen or Music

You may search a screen or a Music by Progress or Title/Chapter/Track.

Searching by Time



1

Press double times GOTO () button.

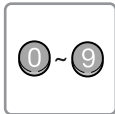

2

If you want to search 1hr 5min 15sec, press 0, 1, 0, 5, 1, and 5 followed by ENTER button.
• Then the screen after the selected hour will be played.

Searching by Title or Chapter



1

Press GOTO () button.



2

Press ◀ or ▶ button to move to the Title/Chapter menu.

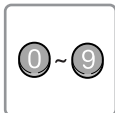

3

After choose your wanted title or chapter and then press ENTER button.



Playing MP3 Disc.

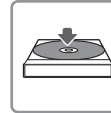

1

Put in a Disc.

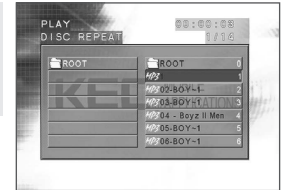

- Make the printed side of the disc face upward.
- As it enters, the first song is automatically played.

- Press STOP () button to stop play.
- Press PAUSE () button to pause play.
- Press PLAY () button to replay.



If you want to play a music.

1. Press ▲ ▼ button to select a music(track) followed by ENTER button. A music will be played.
2. Input number keys and use ENTER button to play the music of a number rightly.

- Note**
- Up to 7 tracks will be appeared per display.
 - Press () or () button to listen to the next or previous music.
 - When it is going to other folder song if should be stop and move button.

❖ About MP3 File

- MP3 files shall be in the format of ISO 9660 or JOLIET.
- The file name of MP3 shall not contain special marks(\, /, :, *, !, " , < , > , | , ...)
- You are not allowed to record unwritable MP3 files.
- MP3 discs may not be played depending on the recording condition.



Photo View by JPEG Disc

Photo View by JPEG Disc



1

Put a disc in.

- Make the printed side of the disc face upward.

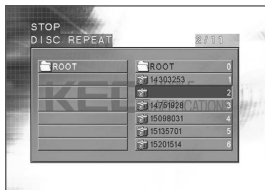

1. Press ▲▼ button to select a photo.
2. Press NEXT/BACK button while a photo is viewed to move to the next/previous photo.
3. Press ◀▶ button to rotate the photo by 90° > 180° > 270° > ORIGINAL step by step.
4. The picture is reversing up and down in the case pressing ▲ button.
5. The picture is reversing left and right side in the case pressing ▼ button.
6. After Zoom on, by FR button the size could be down to 50%, 25% by FR button the size could be up to 150%, 200%.
Zoom one more time and it is off.

- Note**
- Only the files with the extension of JPG/JPEG are to be viewed.
 - The JPG file name shall not contain special marks (\,/,;*,!,<,>,|,...)



MPEG4 DISK PLAY

PRIOR TO PLAY

- MPEG4 file is not workable by recorded status, Disk status, recorded method and kinds of file.
- Workable Video format are AVI, MPG, MPEG but for WMV, RAM, ASF are not possible of working.
- Smaller than Resolution greater Pixel size 720 X 480 (Width x Height) is applicable.
- Screen frame has to be 30/ second, the bigger difference the bigger problem on working.
- In the case of playing recorded high definition resolution file (1.5M BITE) of VIDEO BITRATE could stop of working screen or could cut voice sound.
High definition file has to be used in memorized by DVD disc.
- In the case of subtitle digit, English 49 letters , Words 25 letters including empty space.

FOR PLAYING

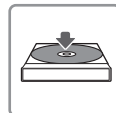

1

Put in DISK.

- The printed side has to be upper side.
- The first song is working.

- Press STOP (STOP) button for stop playing.
- Press PAUSE (PAUSE) button for stop working in a short time.
- Press PLAY (PLAY) button for playing.

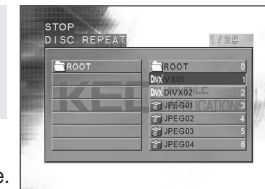

For choosing your wanted song.

1. After moving your wanted file, you can choose with choosing button.
2. After keep in figure you can choose your wanted file.

- Note**
- By 7 Files could be seen on screen.
 - Press Button (◀▶) for playing next file or prior file.
 - On the file list MPG, MPEG file is expressed in VCD and AVI file is expressed DIVX.
 - Not readable WMV, RAM, ASF files are expressed as " ? "
 - Subtitle file is expressed as " ? "



Troubleshooting

Take the following measures at first and further turn the product off and call our Service Center.

The disc is running but the screen does not appear or it is poor or shaking.	<ul style="list-style-type: none"> · Check if TV is turned on. · Check the connection. · Check if the main body is paused. · Check if the disc contains foreign materials or is damaged. · Check the original condition of the disc.
The sound quality is not even.	<ul style="list-style-type: none"> · Check the connection plug. · Check if the connection port is stained with foreign materials.
The remote control does not operate.	<ul style="list-style-type: none"> · Check the angle and distance of the remote control. Check any obstacle. · Check if batteries are sufficiently charged.
There is no image or sound or the disc come out in 2~5 seconds.	<ul style="list-style-type: none"> · Isn't the product installed in too cold or hot place? The optimum temperature for the operation ranges 0°C~50°C
Nothing plays.	<ul style="list-style-type: none"> · Check the existence of a disc. · Check the power voltage. · Check if the right side of a disc was faced upward. · Check if the disc area code. · Check the disc condition.



Troubleshooting

No sound	<ul style="list-style-type: none"> · Aren't you operating in the SLOW or SEPARATE mode? (There will be no sound in the Flexible Speed Screen Play mode.) · Check the connection and further if SETUP is correct. · Is the disc inserted right?(Make the printed side of the disc face upward.) · Check the disc condition.(Keep it clean.)
The product does not operate as per the initial setup condition.	<ul style="list-style-type: none"> · By the specification, some discs may not obey the default condition. Only the disc that has the same function with the SETUP menu will operate.
TV Aspect selection is impossible.	<ul style="list-style-type: none"> · DVD discs are manufactured in the 16:9 Wide, 4:3 Movie, and 4:3 Zoom screen according to the manufacturing condition. Each type always its own rated screen. · Check the DVD disc case to select the function proper for a motion. For your reference, the 4:3 standard disc may not be seen wide.
Disc Audio or Subtitle language which was selected does not operate.	<ul style="list-style-type: none"> · Only the disc audio/subtitle language recorded in a DVD disc can be played.
During DVD play, the Screen Angle doesn't operate.	<ul style="list-style-type: none"> · Screen Angle is available only when the content by angles is recorded in a DVD disc. In such a case, the angle mark  shall be printed in the product or VFD.



Product Specification

DVD Mode Video Output Method		NTSC/PAL
TV Mode Broadcasting Method		NTSC/PAL
Voice Response		20Hz ~ 20KHz
Voice S/N Ratio		90dB
Output	Audio Analog	2.0 Vrms Impedance : 10K Ω
	Video	1.0Vp-p Impedance : 75 Ω
Power		DC 12V~24V, 0.8A
Power Consumption		10W
Product Size		178(D)x175(W)x50(H)
Weight		1.3Kg
Allowable Operating Temperature		0°C ~ 50°C
Allowable Operating Humidity		0% ~ 80%
Allowable Operating Condition		Horizontal

* Design, accessories, and product specification may be changed without notice.



REFERENCE

KEC MOBILE APPLICATIONS TRI-MODE REMOTE CONTROLLER # RC9799 (or # RR9799)

The Tri-Mode Remote Controller is packaged with most KEC LCD Systems. In addition to full remote control of the LCD System, it also provides basic remote control commands for our DVD and Videocassette Players.

To control the DVD-3 with the RC9799 (or # RR9799), press the DVD MODE button. To change to VCP control, press the VCP MODE button.

Notes:

- The LCD System control buttons are always available. They are not affected by the DVD/VCP MODE buttons.
- This unit is not a universal remote controller. It is only designed to transmit control codes to KEC Mobile Applications products.

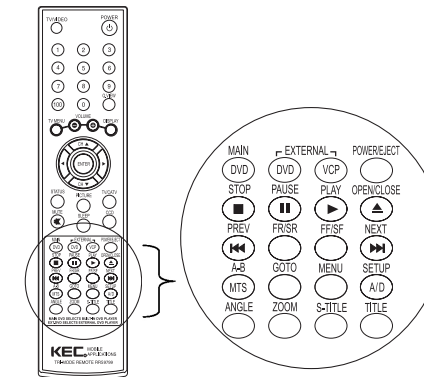
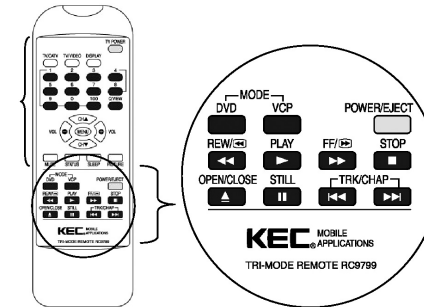



REFERENCE

A NOTE TO INSTALLERS CONCERNING THE KEC R-LINK SYSTEM

Most KEC Mobile Applications video products (TV, LCD, VCP & DVD) employ our R-LINK System. This allows all of our components to be remote controlled even if some of the components are hidden from view.

If you are installing the DVD-3 along with one of our TV's or monitors and one of our VCP's:

1. Connect an R-Link cable from the KEC TV/Monitor to the DVD-3's R-Link Input
2. Connect an R-Link cable from the DVD-3's R-Link Output to the R-Link jack on the rear panel of the KEC VCP.

All KEC components may now be remote controlled by pointing any of the KEC remote controllers at the remote sensor on any of the KEC components.

Please note that since pairs of KEC Mobile Applications Headrest Monitors are designed to be operated independently of each other, they are not equipped with R-Links. Please refer to the installation information accompanying our Headrest Monitor Systems for information on the use of R-Link in conjunction with those systems.



MEMO



MEMO



MEMO